

HawkEye Elite® Alignment Systems

Greater profit and productivity through innovation



Hunter's latest productivity features!



PATENTED

Revolutionary adaptor design!

- ✓ Faster setups!
- ✓ No metal-to-metal contact!
- ✓ No knob twisting!



PATENTED

Superior target design!

- ✓ Lighter design!
- ✓ Narrower profile!
- ✓ Faster readings!

HawkEye
Elite





EXCLUSIVE

QuickComp™!

Compensate all wheels and capture initial measurements in one motion.



NEW

Faster Caster!

Saves time, increases speed and reduces battery drain from brake light draw.



PATENTED

High-resolution cameras!

Four high-resolution cameras provide alignment measurements with pinpoint accuracy.



EXCLUSIVE

New console design!

Integrated storage and charging for popular accessories.*



PATENTED

OPTIONAL

Patented steering system reset integration!

Reset computerized steering systems on a wide variety of vehicles with one simple tool.

* Remote Indicator and Tread Depth tool sold separately.

QuickGrip® wheel adaptors & three-dimensional targets

Hunter's patented QuickGrip® adaptors and three-dimensional targets accelerate service with set-up times in seconds instead of minutes...

HawkEye
Elite



PATENTED

Extremely Fast Installation

- ✓ Spring-loaded arms grip the tire
- ✓ Thumb switch secures the clamp
- ✓ Off-center clamping has no effect on accuracy



PATENTED

Avoid Damage to Expensive Rims

- ✓ Grips tire, not rim
- ✓ No metal-to-metal contact
- ✓ Only protective ring contacts rim



PATENTED

Less Weight

- ✓ Weighs only 2.7 kg (6 lbs.)
- ✓ Nearly 50% lighter than previous designs



PATENTED

Space-Efficient Profile

- ✓ Approx. 228 mm (9 in.) profile
- ✓ Easy to work around
- ✓ Great for narrow bays

Targets



PATENTED

Quick-Change Arms



- ✓ Interchangeable arms cover up to 940 mm (37 in.) assemblies
- ✓ One arm fits approximately 90% of applications

PATENTED

Deep-Wheel Extension



- ✓ Deep rims or protruding hubs, no problem
- ✓ Standard accessory

PATENTED

Wide-Angle Targets



- ✓ Perform max steer procedure, as needed
- ✓ Standard accessory

PATENTED

Low Maintenance

- ✓ Shop-tough polymer structure withstands drops
- ✓ No electronics, cables or calibration
- ✓ Only occasional cleaning required



Previous setups used valuable shop time...

Conventional electronic-sensor system – 10-minute-plus procedure



- ✓ Chock wheels and lift vehicle
- ✓ Jack up front and rear of vehicle
- ✓ Check air pressure and recall specs
- ✓ Mount all 4 sensors, compensate each sensor, and remove pins
- ✓ Lower rear and front of vehicle and jounce
- ✓ Steer caster
- ✓ Print results

10:05 Total

ACTIVITY TRACKER



Older technology requires long set-up times...

Camera-sensor systems speed up the process



- ✓ Chock wheels and lift vehicle
- ✓ Check air pressure and recall specs
- ✓ Mount targets
- ✓ Roll backward, then forward to compensate
- ✓ Remove pins
- ✓ Steer caster
- ✓ Print results

4:00 Total

ACTIVITY TRACKER

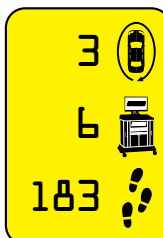

Early camera technology improved efficiency...

...Today, present your results in just 70 seconds!



Hunter's HawkEye Elite® and Premium RX Lift capture all readings and produce measurements in 70 seconds!

Hunter's 70-second procedure

- ✓ Chock wheels and raise lift to work height
- ✓ Mount targets and set air pressure
- ✓ Roll forward to compensate sensors
- ✓ Scan VIN to recall specs and perform faster caster steer
- ✓ Vehicle results print automatically

1:10 Total

ACTIVITY TRACKER

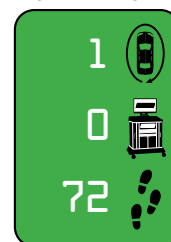

trip around the vehicle

trips to the console

total walking steps



Fast printouts in 70 seconds!

Use detailed printouts featuring your company's logo to sell more work.

FIA *Fully Integrated Alignment*



FIA streamlines the entire alignment process.

Communication links automate tasks once performed by the technician manually, eliminating time-consuming trips around the vehicle and to-and-from the console.



1



PATENTED

RX Scissor Lift console

- ✓ Raising the vehicle triggers the sensors to look for wheel targets
- ✓ Control PowerSlide® and Inflation Station settings on the lift console
- ✓ Store CodeLink tool near the vehicle to save steps



AlignLights turn on automatically at alignment height

2



PATENTED

WinAlign® console

- ✓ Centralized control of entire system
- ✓ Communicate directly with lift to set tire pressure and automatically operate turnplates and slipplates
- ✓ Guide the technician through the alignment process



Measurements are taken automatically after the fourth target is installed

3



PATENTED

PowerSlide® system

- ✓ Slipplates and turnplates automatically lock and unlock at appropriate times
- ✓ No more struggles with lock pins



Auto-locking turnplates and slipplates save trips around the vehicle

4



PATENTED

Inflation Station

- ✓ Automatically inflate all four tires simultaneously
- ✓ Record starting and final pressure
- ✓ Hose recoils to keep work area clear

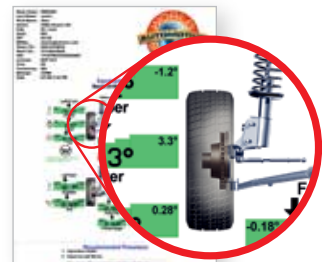

Software tracks before and after tire pressures for the customer's printout

Hunter's Safety System Alignment: Over 100 million vehicles require Safety System Alignment... and growing!



Electronic Stability Control

- ✓ Since 2009, Hunter has supported electronic steering system resets as required by the (OEM)
- ✓ Several systems use electronic steering system output to determine the vehicle's travel direction



Source: Hunter Engineering Company research



**One tool replaces
multiple OEM
scan tools**

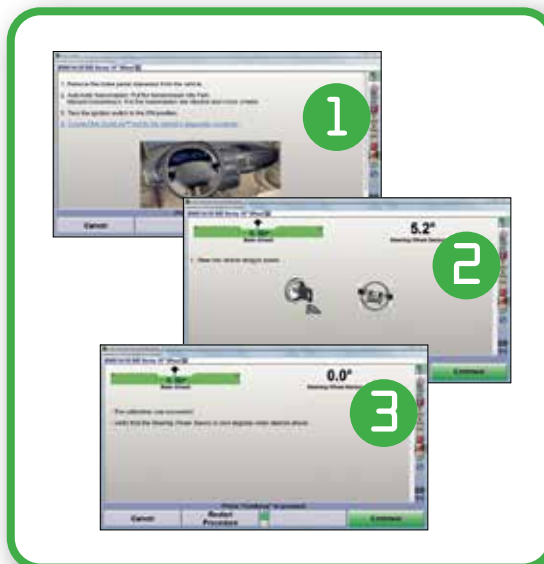

**Simplified reset
instructions
replace confusing
OEM procedures**



The only integrated, complete alignment procedure



CodeLink's patented integration "links" the vehicle OBD-II system to the aligner to align safety system related sensors to the vehicle's alignment geometry.

CodeLink® advantages:

- ✓ Integrated with Hunter WinAlign® systems
- ✓ Simple instructions shown on aligner screen
- ✓ Only one tool required
- ✓ Wireless communication with aligner
- ✓ Resets safety systems and other related sensors*
- ✓ Alignment printouts document reset

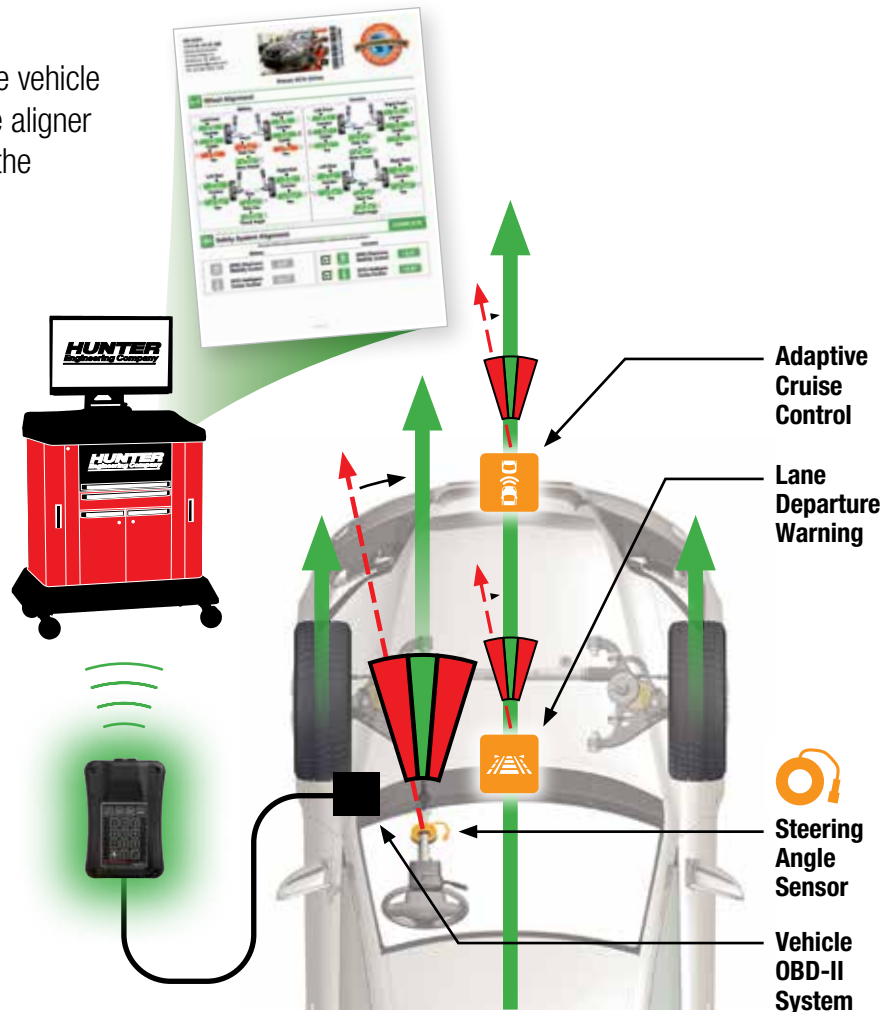

Finishes the job right

- ✓ No other reset tool matches CodeLink's patented integration with the alignment procedure
- ✓ Guarantees precision with exact steering system sensor thresholds
- ✓ Reduces errors that result in customer comebacks

Printed documentation confirms that steering system reset was completed properly

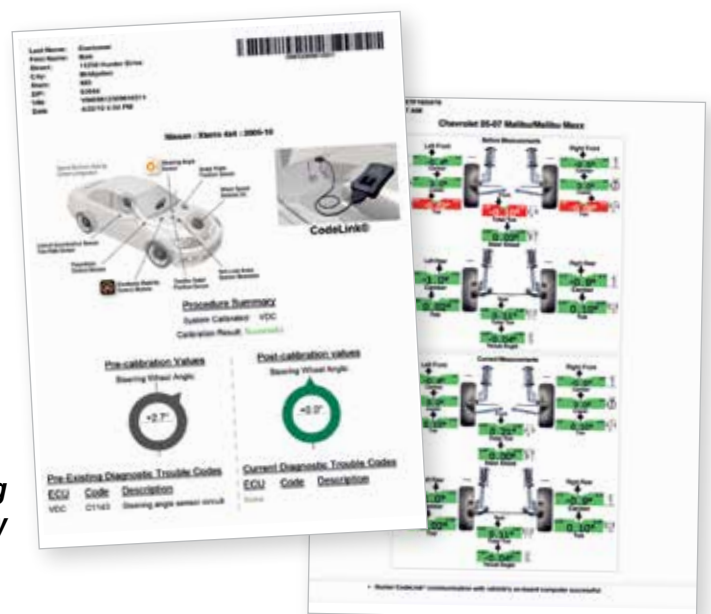

When it comes to award-winning software, WinAlign® is unmatched!

The importance of software...



Over 30 years of experience and the largest R&D department in the undercar industry bring you the most profitable and productive software on the market.

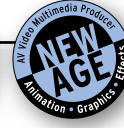

- ▶ The **most extensive** vehicle information database.
- ▶ **Vehicle-specific** procedures guide your technicians with step-by-step instructions.
- ▶ **Patented and award-winning power tools** complete the work accurately the first time, every time.
- ▶ **WinAlign maximizes profit and productivity in your alignment bay.**



Ordinary systems simply present alignment readings



Ordinary camera systems simply speed up these readings

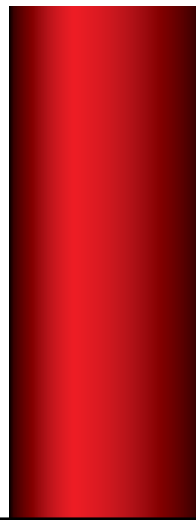

WinAlign maximizes profit and productivity in your alignment bay

New Faster Caster procedure!

- ✓ Eliminates wait times during caster measurement steering sequence
- ✓ Saves time and increases speed
- ✓ Reduces need for brake pedal depressor installation by 86%
- ✓ Reduces battery drain from brake light power draw

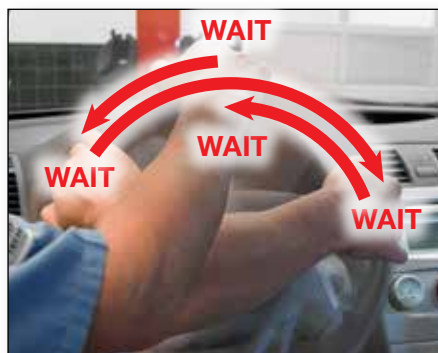

No more waiting for left, right, and center readings during caster measurement steering sequence

NEW



Steer left, right and back to center



ExpressAlign®

Perform every alignment with a streamlined procedure. ExpressAlign analyzes each job and presents the optimal action sequence with the minimum steps required.

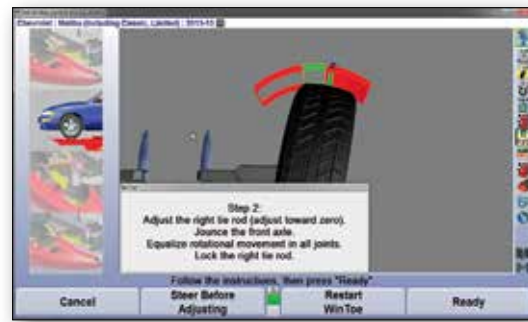

WinToe®

Ensure a straight steering wheel every time without repeated adjustments or using a steering wheel holder.

H A timesaver on nearly every alignment

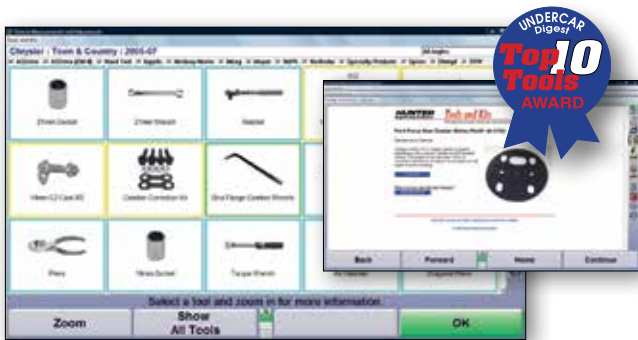

Tools and Kits Database

Save trips back and forth to the tool box. Hunter presents all of the tools and aftermarket correction kits needed for each alignment.

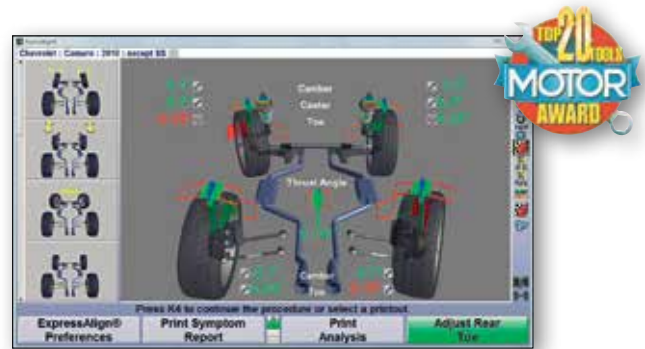

Virtual View®

See your alignment job in 3-D using real-time 3-D graphics. Used by experts and novices alike.

H Every alignment can be shown in 3-D



Control Arm Movement Monitor®

Cut adjustment times in half for front-shim, dual-cam or dual-slot vehicles. Step-by-step graphics let you get it right on the first try.



Wheel-Off Adjustment

Speed the alignment process by making adjustments with the wheel removed.*

H Available when you need it

* For three-dimensional targets, both Wheel-Off Adjustment Kit and SCA Adaptor Kit 20-2664-1 is required.

Take your alignment business to the next level!

Perform body shop and specialty alignments...

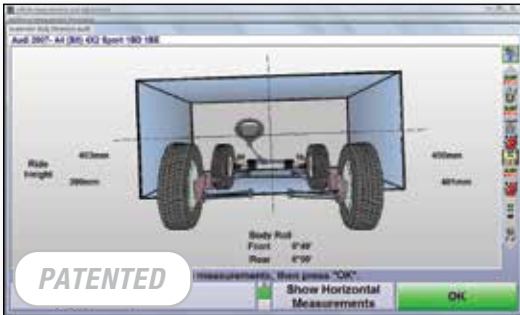

Suspension Body Dimension Audit

Quickly screen vehicles to determine alignability and collision repair needs.

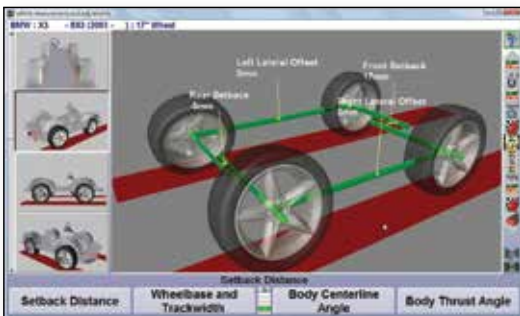

Symmetry Angle Measurements

Instantly access symmetry angles and setback for your body shop customers.

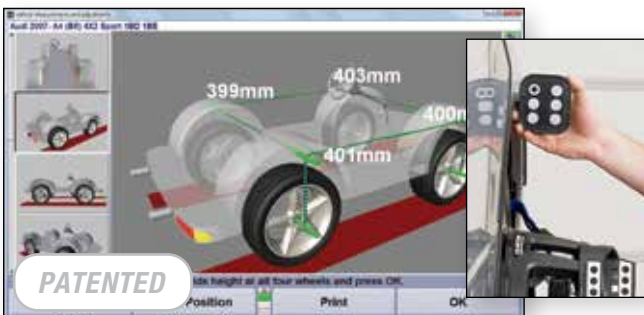

Live Ride Height Adjustment

Measure and adjust ride height in real-time.

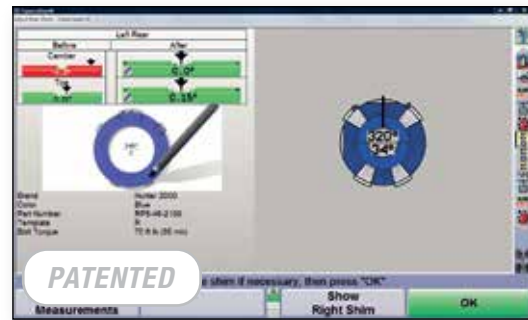

Shim-Select® II

Eliminate confusing shim charts and tables. Shim Select II quickly calculates and displays the template you need for proper shim installation.



Automatic Bushing Calculator®

Calculate the proper bushing size and position adjustment without wasting time with a zero bushing.



Enhance your point-of-sale performance

Provide front-shop personnel with quick, convenient access to vehicle-specific undercar information to explain and sell service.

Help your customers make informed decisions!



WinAlign® printouts help sell work

Explain needed parts and repairs and show completed work to customers using detailed, color-coded printouts.

Clear and detailed printouts help you communicate and build rapport with your customers and sell more alignments



WinAlign® Video Library

400+ videos and animations cover all aspects of wheel alignment today.

- ✓ Educate your customers
- ✓ Find answers to unusual problems
- ✓ Extend your service and profit opportunities
- ✓ Strengthen technician competency



Point & Click Inspection Photos

5,000+ vehicle-specific photos and illustrations to assist your shop

- ✓ Show your customers their hidden repair needs
- ✓ Guide your technicians to the proper inspection points
- ✓ Extend your service and profit opportunities



The latest specs available online

Download, access and communicate alignment service information through the Internet.

Use your aligner to perform Quick Checks!



Use detailed printouts featuring your company's logo to sell more work

- ✓ Total toe front and rear
- ✓ Camber on all wheels
- ✓ Tire wear indication
- ✓ Identifies vehicles that require Safety System Alignment



OPTIONAL

20-2813-1 CodeLink*

Retrieves emission codes. Wirelessly transfers important vehicle information to console.



OPTIONAL

20-2781-3 Battery Health*

Tests battery to OEM specs. Sends results to console wirelessly in 10 seconds.



OPTIONAL

20-2782-1 Tire Tread Depth*

Quick and easy tire wear check. Conditions transmitted to console automatically.



OPTIONAL

Quick Tread®

Creates a 3D model of the tire and can be easily added to existing Quick Check® inspection systems.

*Requires WinAlign® 14.1 software or higher in Quick Check® mode.

Choose the right alignment console for your shop!

WinAlign WA600 Premium consoles

| | | |
|----------------------------------|-----------------------------------------------|----------------------------------------------------------------------------------------------------|
| Industry-leading hardware | Processor | 3.30 GHz Intel® Core™ i3 |
| | Memory | 4 GB of DDR3 SDRAM |
| | Hard drive | 120.0 GB Solid State Drive (or greater) |
| | DVD-RW/CD-RW combo drive | Standard |
| | Monitor class | 609 mm (24 in.) or 685 mm (27 in.) widescreen LCD 812 mm (32 in.) available on large console |
| | Wired & wireless network module | Standard |
| | Operating system | Windows 10 IoT Enterprise |
| | Three-dimensional target (TD Target™) support | Standard |
| | Large console with drawers | Standard (with WA680 consoles) |
| | Compact console with printer drawer | Standard (with WA670 consoles) |
| | Console-top storage and charging station | Standard (with mobile WA600 consoles) |



Large console



Compact console



Wall-mount console

| | | |
|-----------------------------------------|----------------------------------------------------|--------------------------------------------------------------------------|
| Award-winning productivity tools | <i>PATENTED</i> Award-winning WinAlign® software | Standard |
| | <i>PATENTED</i> Vehicle Info Database (30+ yrs) | Standard (2 years free updates) |
| | <i>PATENTED</i> Real-time specs delivered by web | WebSpecs® (2 years standard) |
| | <i>PATENTED</i> Steering system reset (integrated) | Yes (with standard CodeLink™) |
| | Quick Check | Standard |
| | <i>PATENTED</i> Live Ride Height adjustment | Optional |
| | <i>PATENTED</i> Fully Integrated Alignment | Yes (FIA-equipped lift required) |
| | <i>PATENTED</i> Vehicle inspection with photos | Optional |
| | <i>PATENTED</i> Tools & Kits | Videos and Photos |
| | Equipment video help/assistance | Optional |
| | <i>PATENTED</i> ShopResults (via ShopResults.NET™) | 2 years standard |
| | <i>PATENTED</i> Training and productivity aids | 4,000+ photos, 1,600+ illustrations Optional 400+ videos & animations |

Choose the right sensor package for your shop!



Fixed-column configurations fit most service bay applications.

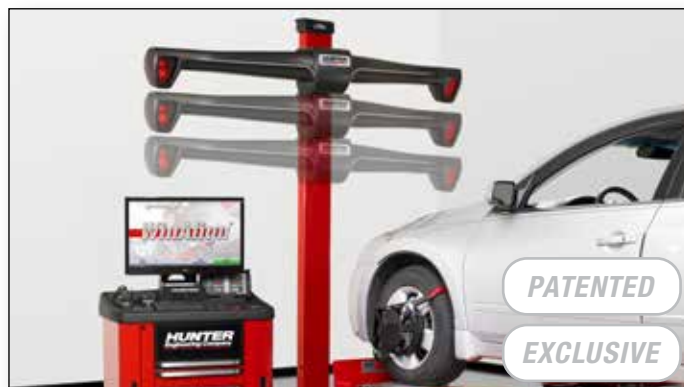

Motorized and manual movable-camera configurations provide a full range of vertical travel for additional lift height.

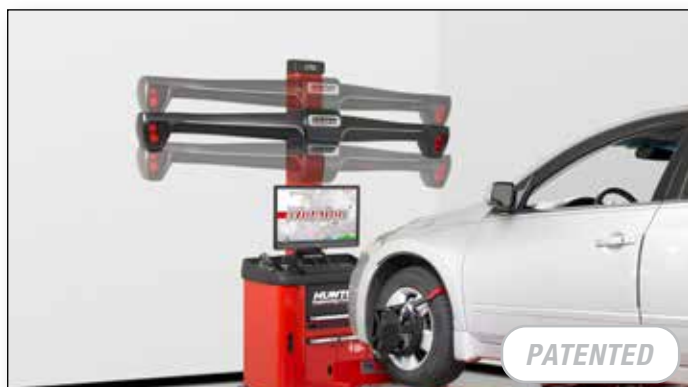

Cabinet-mounted configuration is mobile to service multiple alignment bays and provides a full range of travel for additional lift height.



Wall- and ceiling-mount configurations are perfect when space is at a premium.



Floor-mounted overhead configurations accommodate unique applications.

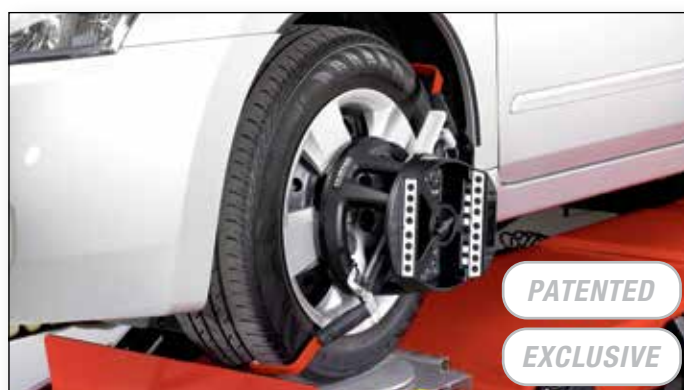

HawkEye Elite® sensors (HE421) come equipped with QuickGrip® adaptors and three-dimensional targets.

HawkEye Elite® alignment sensor and adaptor specifications



| | | | |
|--------------------------|-------------------------------|------------------------------------------|----------------------------------------------------------------|
| Specifications | <i>PATENTED</i> | No metal-to-metal contact with wheel | Standard |
| | | Weight of assembly | 2.7 kg |
| | | Profile of assembly | 228 mm |
| | | Installation time per wheel | 5 seconds |
| | | Rolling compensation style | Forward |
| | | Camera resolution | 2,608 x 1,952 (pixels per camera) 20,000,000 (pixels total) |
| | | Maximum track width | 2032 mm |
| | | Maximum wheelbase | 5334 mm |
| | | Distance to wall* | 1676 - 2717 mm |
| | | Suggested distance* | 2514 mm |
| | | Short-bay distance (see site info)* | 1676 mm |
| | Secondary Measurements | | S.A.I. and included angle |
| | | Setback | ✓ |
| | | Maximum steering angle** | Lock-To-Lock |
| <i>PATENTED</i> | | Live ride height*** | Optional |
| | | Wheelbase difference | ✓ |
| | | Track width difference | ✓ |
| | | Tread width difference | ✓ |
| | | Lateral offset | ✓ |
| | | Rear setback | ✓ |
| | | Axle offset | ✓ |
| Body Measurements | <i>PATENTED</i> | Suspension & Body Dimension Audit (SBDA) | ✓ |
| | <i>PATENTED</i> | Body angle | ✓ |
| | <i>PATENTED</i> | Body wheel offset & setback | ✓ |
| | <i>PATENTED</i> | Body roll** | ✓ |
| Adjustments | <i>PATENTED</i> | Way Up Way Out WinToe** | ✓ |
| | <i>PATENTED</i> | Wheel-Off Adjustment | Optional |

* Refer to site requirements for exact bay specifications.

** Requires optional wide-angle target extensions.

*** Requires Ride Height targets.

Increase revenue with Hunter merchandising!

Introduce your wheel alignment capabilities and educate your customers with great Point-of-Sale options from Hunter.



Sell more alignments with clear and informative printouts

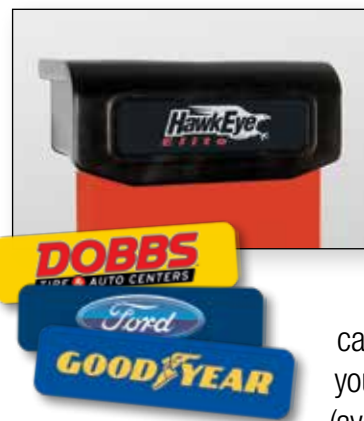

STANDARD

Customized column cap

Make your alignment bay stand out. Hunter's lighted sensor column cap can be customized with your logo or shop name. (available for most sensor configurations)



Be sure to check out other Hunter literature for more quality products from Hunter Engineering.

HUNTER
Engineering Company

www.hunter.com

11250 Hunter Drive, Bridgeton, MO 63044, USA
Tel: +1-314-731-3020, Fax: +1-314-731-0132
Email: international@hunter.com